

Operating Instructions



Operating Instructions HV Temperature Sensor R58-HV-4Kb-xxx / R58-HV-4Kc-xxx 12.2021



Table of contents

1.	Basic information	3
1.1	Notes for the operating instructions.....	3
1.2	Application.....	3
1.3	Intended use	3
1.4	Limitations of the device.....	4
1.5	Warranty and liability	4
1.6	Contact data:.....	4
2.	Safety	4
2.1	Standards and guidelines.....	4
2.2	Design of the safety instructions	5
2.3	Marking/Labeling.....	5
2.4	General safety instructions.....	6
3.	Technical description	7
3.1	Technical data	7
3.2	Structure	8
4.	Assembly	9
4.1	Scope of delivery.....	9
4.2	Assembly.....	9
5.	Commissioning.....	11
6.	Service/Maintenance	11
7.	Accessories.....	12

1. Basic information

1.1 Notes for the operating instructions

These operating instructions contain all important information on the use of the HV temperature sensor R58-HV-4Kb-xxx and R58-HV-4Kc-xxx. You will also find important information regarding your safety.

1.2 Application

The 4-channel HV temperature sensor is available in versions b and c, which differ in their cable construction, the cable outer diameter and the maximum measuring temperature at the active sensor area (see technical data). The HV temperature sensor types K R58-HV-4Kb-xxx and R58-HV-4Kc-xxx is a temperature sensor based on the thermocouple function pursuant to IEC / DIN EN 60584 type K. Due to its special design and increased dielectric strength, it is intended for temperature measurements in automotive engineering, particularly in battery and supply management of electric and hybrid vehicles. The HV temperature sensor is to be classified as "measuring accessory for measuring and testing" according to IEC / DIN EN 61010-031. The sensor type R58-HV-4Kb-xxx or R58-HV-4Kc-xxx has a 4-channel design, which means that four temperatures can be measured at different locations. The channel assignment at the connector is depicted in Fig. 2.

The sensor cable is available in three standard lengths as well as in customized lengths from min. 1m to max. 15m. The nominal length is indicated by the last three numbers of the type designation:

- R58-HV-4xKb-010 or R58-HV-4xKc-010 Nominal length 1,000 mm *)
- R58-HV-4xKb-020 or R58-HV-4xKc-020 Nominal length 2,000 mm *)
- R58-HV-4xKb-030 or R58-HV-4xKc-030 Nominal length 3,000 mm *)

*) Standard nominal length

For example

- R58-HV-4xKb-065 Nominal length 6,500 mm customer specific

1.3 Intended use

The HV temperature sensor type K R58-HV-4Kb-xxx or R58-HV-4Kc-xxx is designed for operation in combination with suitable measuring electronics. Please observe the manufacturer's specifications! It is used to measure temperatures between -50 °C and +180 °C (variant b) and +200 °C (variant c) on components of electric and hybrid vehicles in automotive engineering.

Attention! Non-observance of these instructions, improper and inappropriate use, modification or damage to the sensor will result in loss of safety and warranty and liability claims.

1.4 Limitations of the device

- The product features the IP-Code (degrees of protection) IP66 and is protected against moisture, dirt and dust.
- Avoid environments exposed to direct sunlight and temperatures outside the specification. Use the product in appropriately protected areas.

1.5 Warranty and liability

- For safety and approval reasons, unauthorized conversion and/or modification of the product is not permitted. Cable and sensor tip may not be changed or damaged. Do not open the connector.
- Replace the sensor if you notice any malfunctions. Once the malfunctions have been eliminated, have the removed sensor checked by the manufacturer and repaired if necessary.

1.6 Contact data:

RECKMANN GmbH
Werkzeugstraße 19-23
D- 58093 Hagen

Telephone: +49 (0) 2331/3501-0
Fax: +49 (0) 2331/3501-70
info@reckmann.de
www.reckmann.de

2. Safety

2.1 Standards and guidelines

The HV temperature sensor R58-HV-4Kb-xxx and R58-HV-4Kc-xxx correspond to the safety regulations pursuant to IEC/ DIN EN 61010-031 "Safety requirements for hand-held probe assemblies for electrical measurement and test" and is marked with the VDE sign.

2.2 Design of the safety instructions

The safety instructions in this document are marked by safety symbols and are designed according to the SAFE principle. They contain information on the type and source of the danger, on possible consequences and on how to avert the danger.



DANGER

Warns of an accident that will occur if the instructions are not observed. The accident will result in serious injury or death, e.g. by touching electrical units under high voltage.



WARNING

Warns of an accident that may occur if the instructions are not observed. The accident can lead to serious, possibly life-threatening injuries or death, e.g. by touching electrical units under high voltage.



CAUTION

Warns of an accident that may occur if the instructions are not observed. The accident may result in minor injuries such as burns, skin damage or crushing.



NOTE

Important general information.

2.3 Marking/Labeling

The HV temperature sensor types K R58-HV-4Kc-xxx and R58-HV-4Kc-xxx are marked as follows:

- on a labeling field of the connector plug:
 - R58® - Trademark of RECKMANN GMBH
 - Type designation of the HV temperature sensor
 - Serial number
- on a printed hose in the proximity of the connection plug:
 - VDE registration number
 - Symbol:  Warning sign: The operating instructions must be observed!

2.4 General safety instructions



DANGER

Hazard due to dangerous electrical voltages in the event of defective insulation.

- Always check for mechanical damage prior to and during operation.
- If there is any visible damage, take the product out of circulation immediately!



CAUTION

Danger of injury due to improper handling.

- Do not open the device and do not manipulate the device. Failure to do so may result in malfunctions and device defects.

3. Technical description

3.1 Technical data

Technical data		
Version	R58-HV-4Kb-xxx	R58-HV-4Kc-xxx
Description	4-channel thermocouple type K	
Connectors	LEMO CFB.H08	
Management Material External diameter Temperature resistance	PUR/PUR/FEP/FEP 6.1 mm +150°C	PUR/PUR/PI/PI 4.5 mm +150°C
Temperature measuring range at the measuring tip	-50 °C to +180 °C	-50 °C to +200 °C
Voltage range, frequency range and measurement category	DC 935 V CAT 0 AC 600 V (50-100Hz) CAT II	
Transient overvoltage	Max. 2.500 V	
Degree of pollution	3	
Operating height	up to 5.000 m	
Ambient conditions	-40 °C to +105 °C/5 % to 95 % RF	
Degrees of protection	IP 66	
Measuring accessories	NOT hand held	
Storage	In dry interiors at temperatures between -20 °C and +65 °C	
VDE-tested	VDE-testing according to DIN/EN 61010-031 VDE-monitored production facility	 REG.-Nr. E903

Tab. 1: Technical data

3.2 Structure

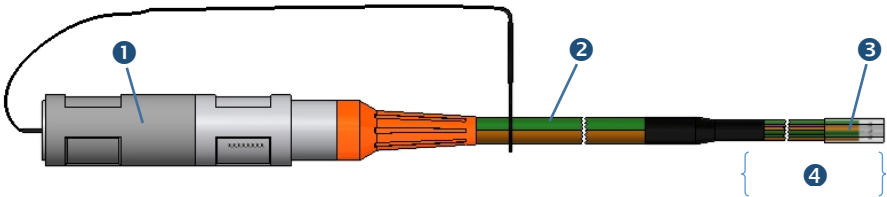

Fig. 1: Structure of the HV temperature sensors R58-HV-4Kb-xxx and R58-HV-4c-xxx

- | | | |
|---|---------------------|--|
| 1 | Cover cap | Protection against contact and dirt during "non-operation" |
| 2 | Wire | Connection between measuring point and evaluation electronics |
| 3 | Sensor tip | Recording of the temperature to be measured |
| 4 | Active range 400 mm | Transmission of the measuring signal to the evaluation electronics |

The temperature sensor (sensor tip) is designed as a type K thermocouple pursuant to IEC / DIN EN 60584. The assignment at the connector plug must be adapted accordingly in the evaluation electronics.

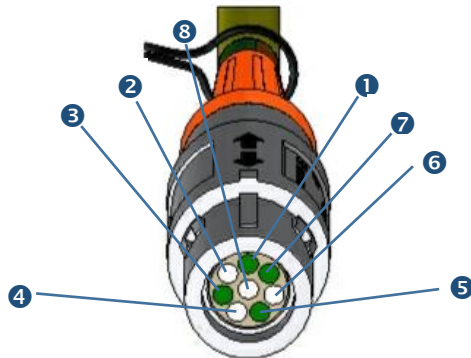

Fig. 2: Assignment of the connector plug (view on pin side)

Sensor 1	Sensor 2	Sensor 3	Sensor 4
1 NiCr green +	3 NiCr green +	5 NiCr green +	7 NiCr green +
2 Ni white -	4 Ni white -	6 Ni white -	8 Ni white -

The temperature sensor (sensor tip) including the stripped area of 400 mm from the sensor tip is suitable for temperatures up to a maximum of +180 °C (variant b) and +200 °C (variant c) (active range).

**CAUTION**

Higher temperatures lead to destruction of the sensor and can impair function and safety.

**NOTE**

It is imperative that the measuring temperatures at the sensor tip and the active area of the cable do not exceed +180 °C (variant b) and +200 °C (variant c)!

4. Assembly

4.1 Scope of delivery

- HV temperature sensors R58-HV-4Kb-xxx and R58-HV-4Kc-xxx completely mounted with removable protective cap
- Operating instructions

4.2 Assembly

The HV temperature sensor R58-HV-4Kb-xxx or R58-HV-4Kc-xxx is mounted and prepared in a quiescent state of the measuring environment.

- The temperatures at the measuring point and the measuring environment are below 50°C.
- During installation, the operating voltage at the evaluation electronics is switched off.

When attaching the sensor tip to the measuring point and installing the cable, it is essential to ensure that the insulation of the sensor and the cable is not damaged.

The connector plug is locked or unlocked by pulling the outer ring marked with arrows forward or backward.



NOTE

When installing the cable, make sure that the bending radius does not fall below: 45mm!
This prevents damage to the insulation and measurement value shifts due to structural changes in the thermal material.

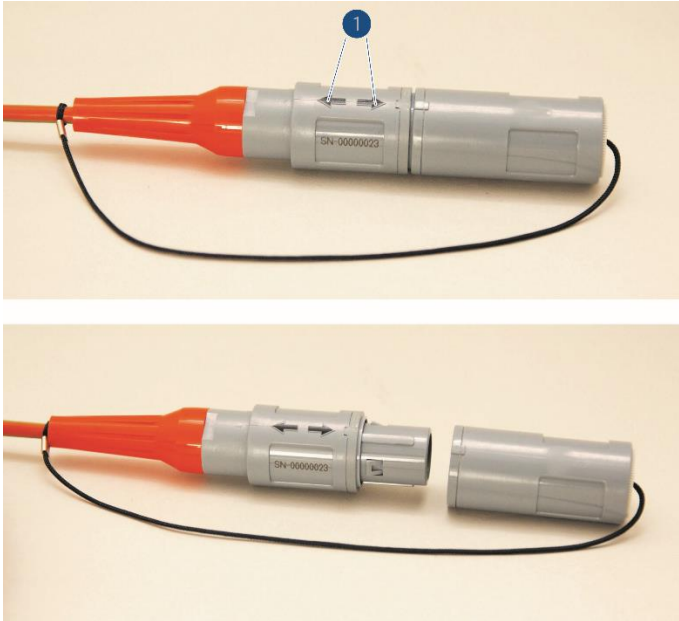

Fig. 3: Actuating the locking ring when removing the cover cap

1 Unlocking / Locking



NOTE

- Make sure that the cover cap is only removed for operation on the evaluation electronics.
- Remove the cover cap as described before plugging the connection plug into the designated socket of the electronic evaluation system. Do not use any force.
- Turn the plug until the locking bars fit into each other and the plug slides easily into the socket. Push the plug in until a stop is felt, and the locking device engages

5. Commissioning

The measurement can be started after inserting the plug connector into the corresponding socket of the evaluation electronics. No further operation is required on the HV temperature sensor R58-HV-4Kb-xxx or R58-HV-4Kc-xxx. The operation is exclusively done via the connected evaluation electronics or the corresponding software.

Status display	Meaning
Evaluation electronics	Please observe the displays of the evaluation electronics.

Tab. 2: Status display

You can detect possible damage with the help of the wear indicator in the cable sheath and, by checking it regularly, you can eliminate the risk of electric shock.

Wear indicator	Meaning
<p>Blue color visible in the outer sheath</p> 	<p>If a blue spot is visible on the orange/green cable sheath, then there is damage and safety is no longer guaranteed! In this case, the HV temperature sensor must be taken out of operation and replaced immediately!</p>

Tab. 3: Wear indicator

6. Service/Maintenance

The HV temperature sensor types K R58-HV-4Kb-xxx and R58-HV-4Kc-xxx work maintenance-free under normal operating conditions. Clean the outside of the sensor with a slightly damp cloth if necessary. Do not use any abrasive cleaning agents.

Make sure to check the wear indicator in the cable sheath on a regular basis!

7. Accessories

The following accessories are available for operating the HV temperature sensor R58-HV-4Kb-xxx or R58-HV-4Kc-xxx:

HV extension

- R58-HV-VL-4Kb-020 or nominal length 2,000 mm (Standard)
- R58-HV-VL-4Kb-030 nominal length 3,000 mm (Standard)

The HV extension is connected between HV sensor and HV evaluation electronics and is used for cable extension.

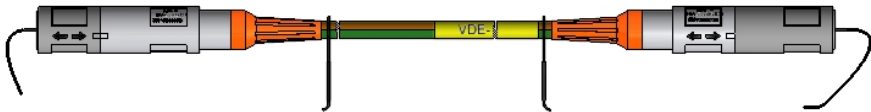

HV adapter 4 to 1

- R58-HV-4K-1K

The HV adapter enables the connection of a 4-channel HV sensor R58-HV-4Kb-xxx or R58-HV-4Kc-xxx to a 1-channel evaluation electronics (e.g. IPETRONIK M-THERMO2 HV).

